



Swiss Enterprises Litigating in U.S. Courts Corporate Veil and other Defense Strategies

EIZ-Event vom 8. Februar 2005 - Europa Institut, Universität Zürich

Peter Honegger



Introduction

Service of Process

Jurisdiction

**Discovery vs.
Secrecy Laws**

Judicial Assistance

Corporate Veil

Default Judgment



Avoid Service of Process

USA: Process Servers
Transient Jurisdiction
Field Case



CH: Art 271 Penal Code
Hague Service Convention



Avoid US Jurisdiction

Minimum Contacts

Long-arm Jurisdiction

Websites

forum non conveniens

Arbitration Clauses

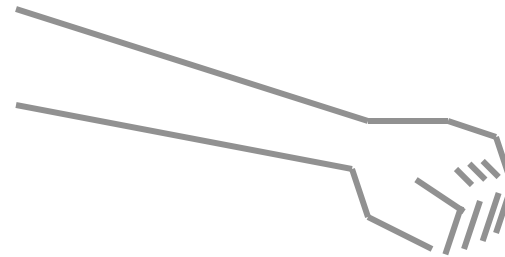

“Any dispute ... shall ..., *to the exclusion of any other court*, be *exclusively* resolved by an *arbitral tribunal* ... pursuant to the Swiss Rules of International Arbitration ...”



Cross Border Evidence Gathering

Art 271 Penal Code

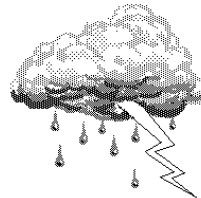

Art 273 Penal Code

Hague Evidence Convention

Aerospatiale Case

WELCOME TO SWITZERLAND

*Lawyers gathering evidence for use in
US court proceedings will be arrested*

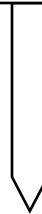
A simple black outline of a downward-pointing arrow, indicating the direction of the warning.



Discovery vs. Secrecy Laws

US Privileges

Protective Order

Banca della Svizzera Italiana Case

Restatement Balancing Test

Good Faith Efforts: “Triage”

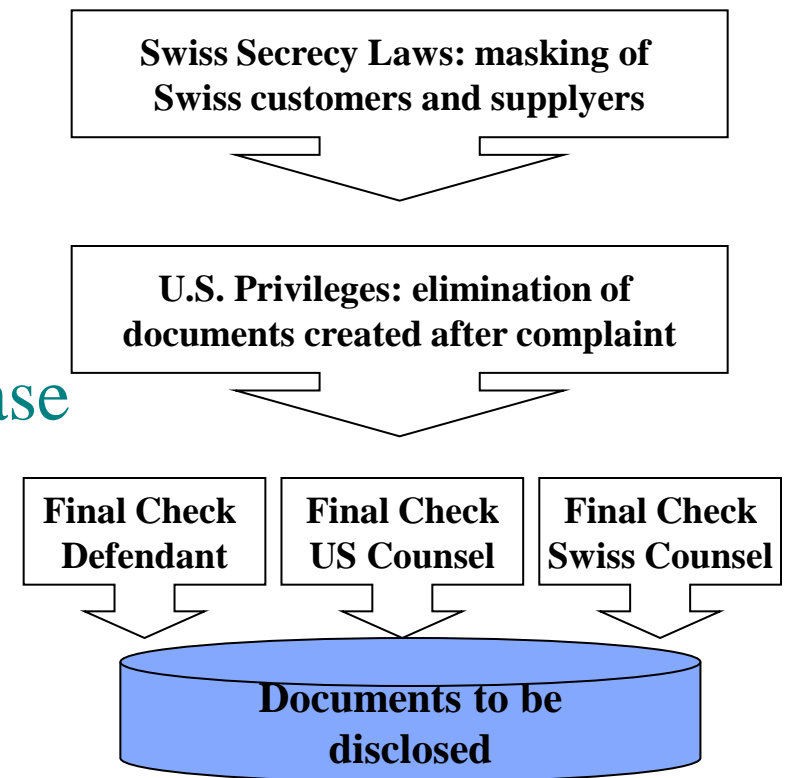



Use Judicial Assistance

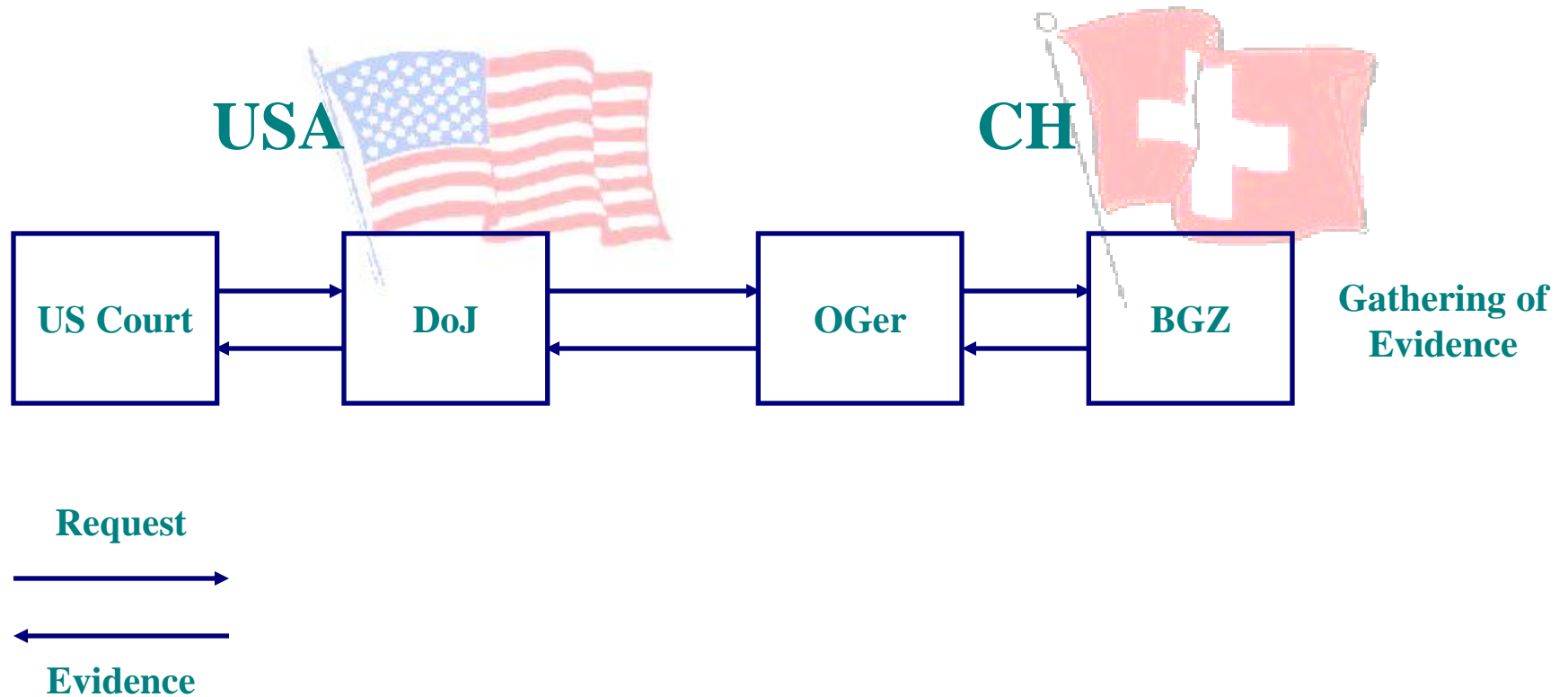



Involve Swiss Authorities

Federal Prosecutor

Swiss Embassy

amicus curiae brief

Marc Rich Saga

Aerospatiale Case

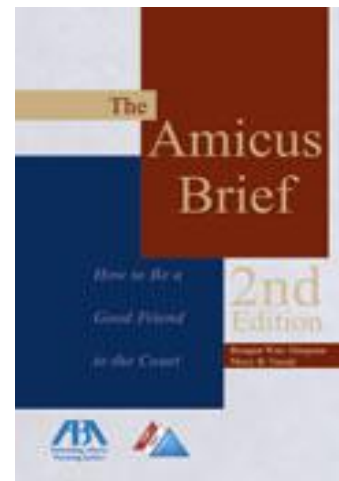



Default Judgment

Swiss Domicile

Duly Summoned

Right to be Heard

Special Appearance





Corporate Veil

No Common Directors / Managers

Observe Legal *formalia*

Avoid Inadequate Capitalization

No Announcement of Dependence

Avoid Instructions

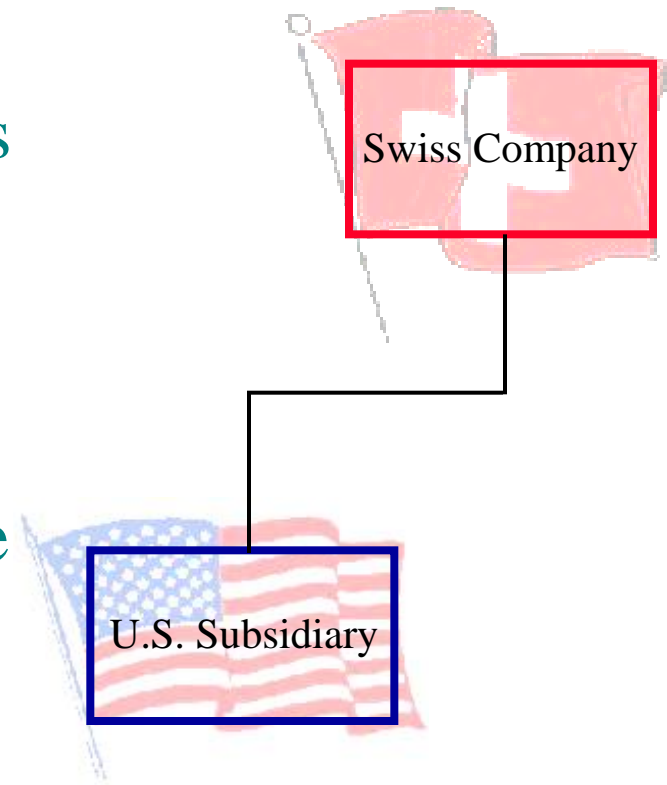



Other Defense Strategies

US Assets

Is Swiss defendant „vulnerable“ in the US?

Driver Seat

Behave proactively, use particularities of US legal system

Red Flags

Early communication of Swiss secrecy laws

Sanctions

Avoid sanctions / bad faith image

Settlement

Pro: Avoid lengthy/expensive proceedings, *Con:* Reputation as „easy settler“

PR

Prepare stand-by press releases, avoid “no comment” strategy